

Note:

THE ALUMINUM CASING OF YOUR SIGNAL BOOSTER WILL ADJUST TO THE TEMPERATURE OF ITS ENVIRONMENT, BUT IS DESIGNED TO PROTECT THE SIGNAL BOOSTER TECHNOLOGY. FOR EXAMPLE, IN THE SUMMER, THE SIGNAL BOOSTER CASE MAY BE AS HOT AS 150 DEGREES INSIDE YOUR VEHICLE. THESE HIGH TEMPERATURES WILL NOT DAMAGE THE SIGNAL BOOSTER, NOR DO THEY POSE A FIRE RISK TO THE VEHICLE. AGAIN, BE SURE TO PLACE YOUR SIGNAL BOOSTER IN A LOCATION WITH ADEQUATE VENTILATION AND AWAY FROM DIRECT SUNLIGHT OR MOISTURE.

THE DRIVE 3G-M SIGNAL BOOSTER MAY REMAIN ON, IN VEHICLES WHOSE 12V DC POWER SOURCES DO NOT AUTOMATICALLY SHUTDOWN WHEN THE VEHICLE IS TURNED OFF. THIS COULD RESULT IN DISCHARGING THE VEHICLES BATTERY IN ONE TO TWO DAYS.

Product Registration

Thank you for purchasing this weBoost product. Please take time to register your new product at our website:

www.weboost.com/us/productregistration

Registering is quick and easy, it only takes 2-3 minutes to complete. Your information is secure, we don't share or sell your information to other third parties.

This device complies with part 15 of the FCC Rules. Operation is subject to the following two conditions: (1) This device may not cause harmful interference, and (2) This device must accept any interference received, including interference that may cause undesired operation.

RF Safety: Any antenna used with this device must be located at least 8 inches from all persons.

FCC ID: PWO460002 IC: 4726A-460002



3301 East Deseret Drive, St. George, UT 84790

web: www.weboost.com | email: support@weboost.com

phone: 866-294-1660 | local: 435-673-5021 | fax: 435-656-2432



111499_Rev02_01.30.15

How It Works

Your cell phone is an essential part of your life. weBoost is here to ensure you have seamless connections on all your cellular devices.

The Drive 3G-M cellular signal booster is an effective solution to all those times you have lost a call while driving your vehicle due to a weak cell signal. Installation is simple and can be completed with minimal tools.

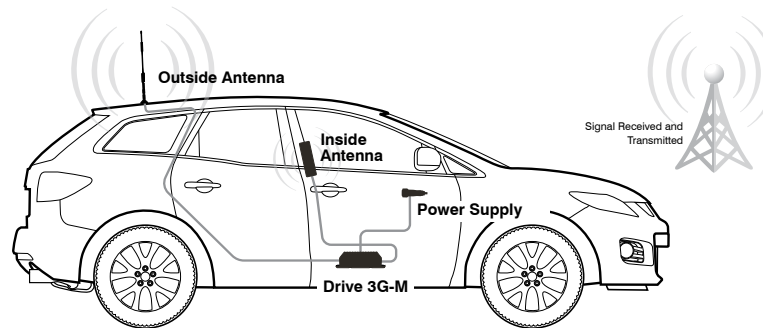

NEED ASSISTANCE? WE CAN HELP!

Contact our U.S.-BASED CUSTOMER SUPPORT:

- Contact our U.S.-based customer support team at 1-866-294-1660 or email at support@weboost.com
- Go online for how to resolve the most common issues at www.weboost.com/us/customersupport
- Find a weBoost Installer on our web site at www.weboost.installernet.com

Installation is simple, but we're here to make it even easier.

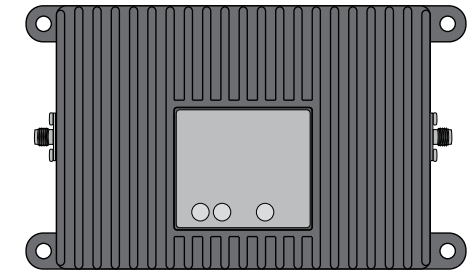

Drive 3G-M™ Quick Install Guide

For more information refer to full Install Guide at:
www.weboost.com/us/installguide/drive3G-M

Package Contents

Drive 3G-M Signal Booster
12" Mag Mount Antenna

Slim Low Profile Antenna
DC Power Supply

Quick Install Diagram

Outside Antenna Installation

Running Antenna Cable

Inside Antenna Installation

Connect Cables to Drive 3G-M / Power Supply Cord

Connect Power Supply

1 Outside Antenna Installation

Select a location on top of the vehicle to mount the 12" Mag Mount Antenna that is:

- Near the center of the vehicle's roof.
- Free of obstructions.
- At least 12 inches from any other antennas.
- At least 6 inches from any windows (including sunroofs).

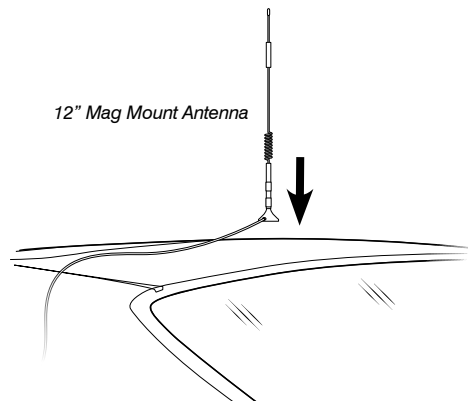

2 Running Antenna Cable

Run the Outside Antenna cable into the car. The cable is strong enough that it may be shut in most vehicle doors without damaging the cable. For a cleaner look, carefully pull down the door seal, run the cable under the seal, and push the seal back into place. This method reduces wear on the cable as the door opens and closes.

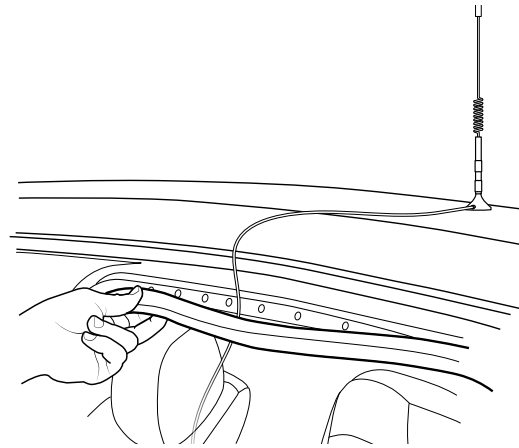

3 Inside Antenna Installation

Identify a place on the side of the seat to mount the Slim Low Profile Antenna. The location should be at least 18 inches but no more than 36 inches from where the cellular device will be used. Peel off the backing of the Velcro® and attach to seat.

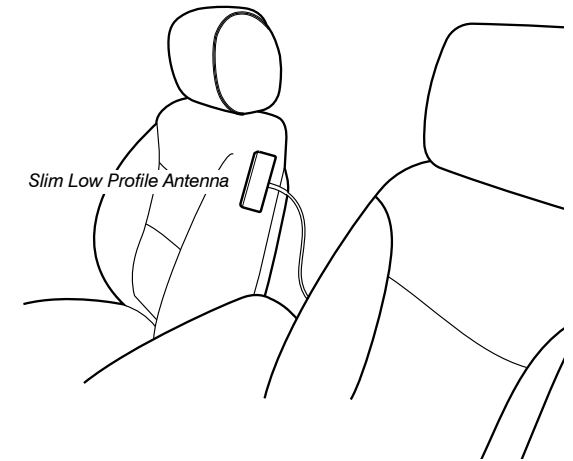

4 Connect Coax Cables to Drive 3G-M

Select a location for the Drive 3G-M that is free from excessive heat, direct sunlight and moisture and that has proper ventilation. Good locations include underneath a seat or under the dashboard. Connect the cable from the 12" Mag Mount Antenna to the port labeled "Outside Antenna" on the Drive 3G-M and connect the cable from the Slim Low Profile Antenna to the port labeled "Inside Antenna" on the booster.

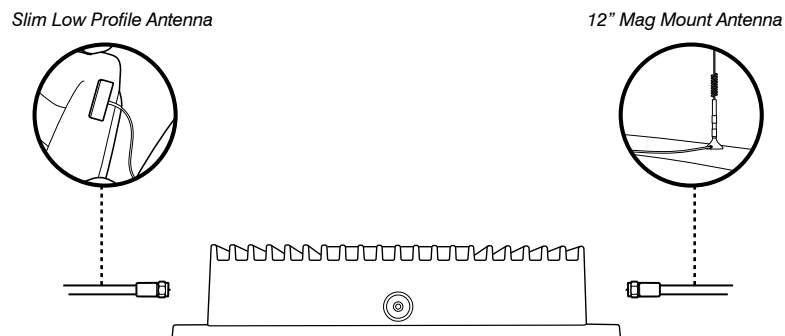

5 Connect Power Supply to Drive 3G-M

Connect the power supply cord to the side of the Drive 3G-M labeled "Power." NOTE: Do NOT connect the power to the Signal Booster until you have connected both the Inside and Outside Antennas.

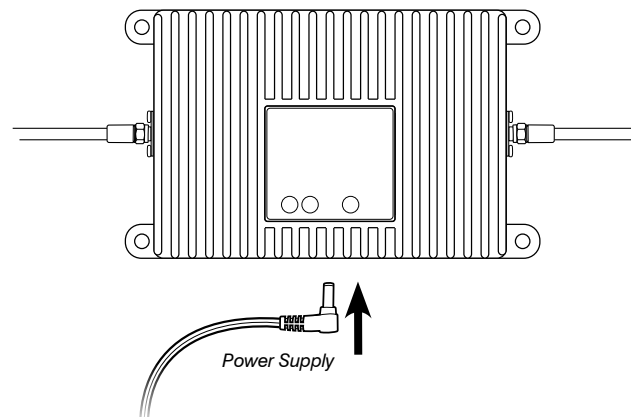

6 Connect to Power Supply

Plug the power adapter into vehicle's 12V DC power supply. Power up your Drive 3G-M by flipping the switch on the back of the DC power adapter on. If your Drive 3G-M is working correctly, the lights will be green.

NOTE: If lights are not green on your weBoost booster, please refer to the full install guide online or contact customer support at 1-866-294-1660 or email at support@weboost.com.

